



KAESER FILTER

Series KF F6 to F320

Clean compressed air at low cost

Flow rate 0.6 to 32.0 m³/min, Pressure 2 to 16 bar

Series KF F6 to F320

Clean compressed air at low cost

KAESER FILTER products are the key components for supplying compressed air of all purity classes as per the ISO 8573-1 standard and they achieve this with extremely low differential pressure.

Furthermore, their service-friendly design not only allows simple, error-free opening and closing of the filter housing, but also enables quick and clean element changes. **KAESER FILTER** products are available in four filter grades. 12 housing sizes provide efficient filtration for flow rates from 0.6 to 32.0 m³/min.

Standard-compliant purity

The **KAESER FILTER** range uses modern deep-pleated filter media to remove particles and aerosols. A highly effective carbon fibre mat traps oil vapours. Together with innovative flow dynamics, they deliver exceptional filtration efficiency with minimal pressure loss. The impressive performance data of **KAESER FILTER** products have been determined in accordance with ISO 12500 and confirmed by the independent "Lloyd's Register" testing agency.

Service-friendly design, straightforward handling

KAESER FILTER products feature a corrosion-resistant aluminium housing and stable filter elements. The practical bayonet lock ensures automatic positioning of the housing and element seals. Both seals are components of the filter element.

This means that a filter housing can be sealed only if a filter element has been inserted. A locking screw prevents unintentional opening of the housing when under pressure and also provides housing venting.

Minimal pressure loss, maximum savings

The efficiency of a compressed air filter depends most of all on pressure loss. **KAESER FILTER** products feature generously sized housings and filter surfaces, innovative flow dynamics and high-performance filter media. These features result in up to 50% lower pressure loss in comparison to other filters on the market – a value that remains virtually constant throughout the entire service life of the filter element. This reduces the load on upstream compressors, thereby creating the potential for significant reductions in costs and CO₂ emissions.

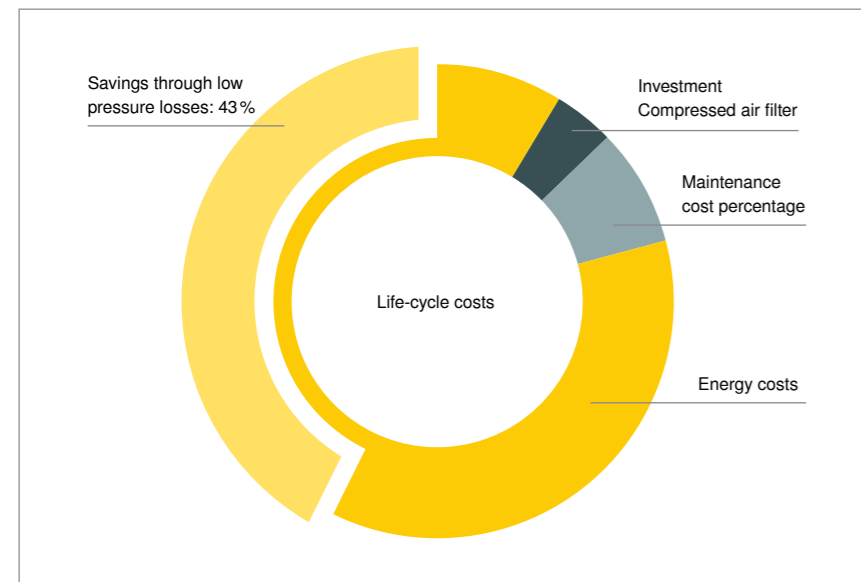

Coalescence filter example

- Flow rate 17.7 m³/min
- 50% lower pressure loss
- 6.55 kW/(m³/min)
- Additional energy requirement 6% per bar
- Power price: €0.2/kWh
- 8760 operating hours p.a.
- Annual debt service over 10 years



Image: Functional schematic of coalescence filter



KAESER FILTER products are available in four high-performance filter grades and can easily be connected to create filter combinations.

When used with compressed air dryers and air-main charging systems from KAESER, they ensure dependable and energy-efficient compressed air treatment where it's needed, when it's needed.

Series KF F6 – F320

Low differential pressure for maximum efficiency

Increased energy cost per m³/min of compressed air: 6% for 1 bar pressure drop. This rule of thumb shows that generously sized KAESER FILTER products pay for themselves quickly.



Large flow cross-section

KAESER FILTER equipment uses filter elements with flow-optimised element heads. The filter inlet is offset towards the air inlet. This increases the flow cross-section at the air discharge side and further contributes to outstanding filter efficiency with minimal pressure loss.



Wide connection flanges

Generously-dimensioned connection flanges on KAESER FILTER products help keep pressure losses to a minimum. Since KAESER FILTER products are available with air connection flanges of various sizes; there is no need for reducer sections when connecting to different air distribution networks.

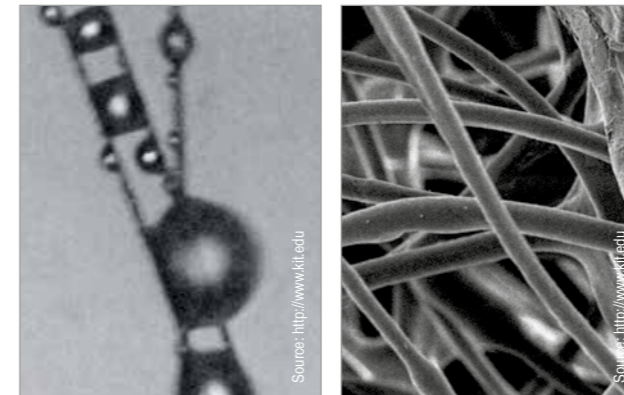

Low flow resistance

The polyester material used in the filter drainage layer ensures rapid oil drainage (left). Moreover, to achieve optimum filtration and contaminant retention with minimal pressure loss, KAESER particulate and coalescence filters feature high void volume filter media (right).

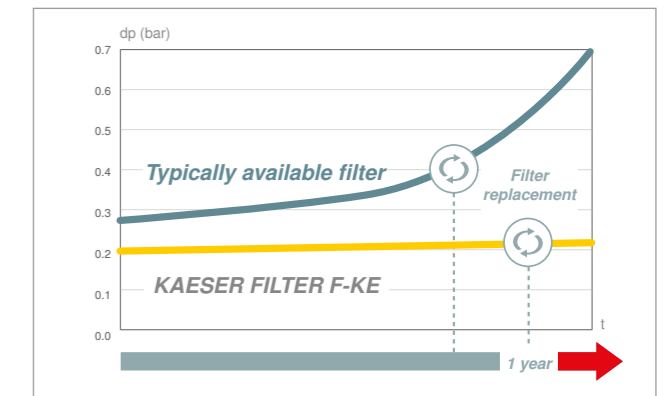

High contaminant retention capacity

KAESER FILTER products demonstrate a lower pressure drop right from the outset compared to other typically available filters on the market. Moreover, the pressure drop remains low for much longer thanks to the high contaminant retention capacity. The result: low operating costs over the long term. The annual maintenance of particulate and coalescence filters mitigates age-related risks and ensures maximum compressed air purity.

Standard-compliant purity in every quality class

The generously dimensioned KAESER FILTER products have proven themselves in the most sophisticated of testing environments and in stringent measurement programs. KAESER FILTER products are dependable and efficient – and are certified to prove so.



Optimum flow distribution

The element head of KAESER FILTER units is optimised for best possible air flow. Its tapered internal structure channels the compressed air to the centre of the element interior for even charging of the filter media. The result: high filtering efficiency with minimal pressure loss.

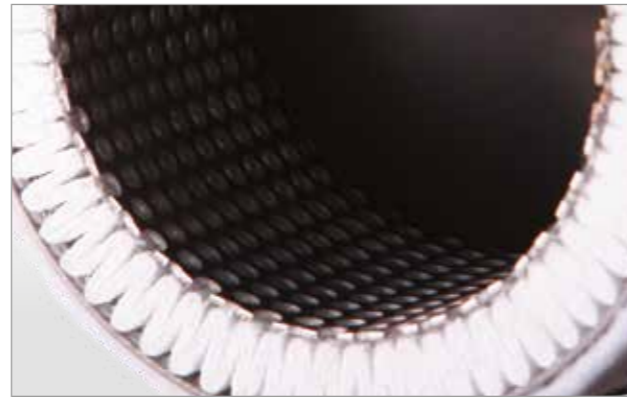

Deep-pleated filter elements

The deep-pleated KAESER particulate and coalescence filter elements feature exceptionally large filter surfaces. Through the resulting increase in efficiency, operating costs are significantly reduced compared to conventional filter designs.

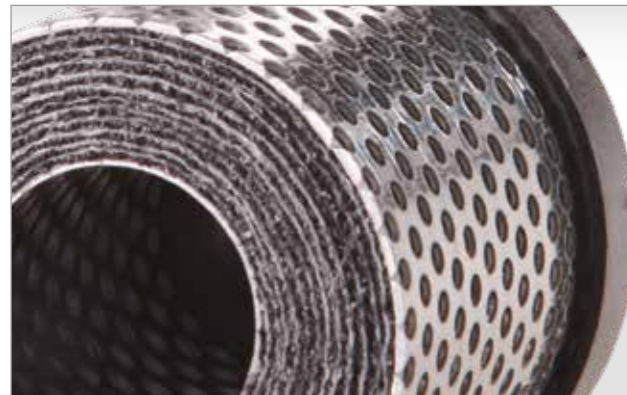

High efficiency carbon matting

Unlike conventional filters, KAESER activated carbon filters with high-efficiency carbon matting prevent channelling whilst also ensuring reduced differential pressure. Moreover, the matting provides highly effective protection against particle release.



Application-tailored combinations

KAESER FILTER products can be flexibly combined onsite with optional connection kits. For example, the "Carbon Combination" consisting of a KE coalescence filter (left) and a KA activated carbon filter (right) not only retains aerosols and particulate matter, but also oil vapour.

Degree of filtration	KB Coalescence filter Basic	KE Coalescence filter Extra	KD Particulate filter Dust	KA Activated carbon filter Adsorption	KBE Extra Combination	KEA Carbon Combination
Initial differential pressure at saturation	< 140 mbar	< 200 mbar	< 30 mbar (New, dry)	< 40 mbar (New, dry)	< 200 mbar	< 240 mbar
Aerosol content at inlet	10 mg/m ³	10 mg/m ³	-	-	10 mg/m ³	10 mg/m ³
Residual aerosol content at outlet as per ISO 12500-1*	< 0.1 mg/m ³	< 0.01 mg/m ³	-	-	< 0.01 mg/m ³	0.003 mg/m ³ (Total oil content)
Filter medium	Deep-pleated with support structure and polyester drainage matting		Deep-pleated with support structure	High-efficiency carbon matting	-	-
Application	Filtration of solid and liquid aerosols and solid particles		Exclusively for filtration of solid particles	Exclusively for removal of oil vapours	Combination of KB and KE; same application as KE, but ensures higher compressed air quality	Combination of KE and KA, filtration of aerosols, solid matter particles and oil vapour

* as per ISO 12500-1:06-2007



Image: Selection from the filter element range



Image: Coalescence filter with ECO-DRAIN 31 F

Series KF F185 – F3360

Safe handling, service-friendly design

KAESER understands customers' needs, as the company itself operates various compressed air stations. From first hand experience, we are well-versed in all aspects of compressed air station planning, implementation, operation and maintenance. We draw on this expertise to create user-friendly and low-maintenance products.



Easy element change

KAESER FILTER units can be easily opened by hand. Servicing is a quick and virtually completely clean process. The filter element can simply be unscrewed once the filter housing with element is released from the head. Minimal installation space is required beneath the filter.

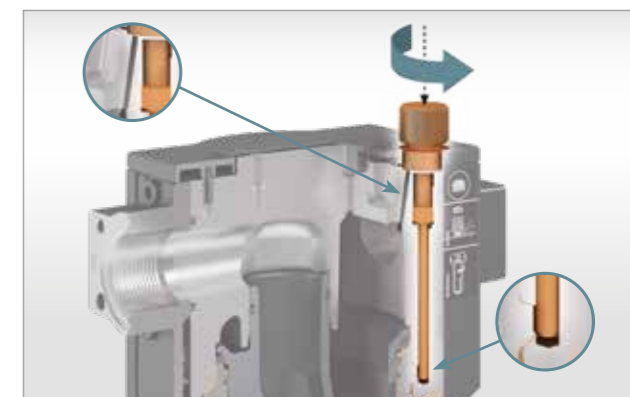

Safe opening

A locking screw protects the filter housing from unintentional opening. If released, a seal is broken and a vent hole is uncovered. If pressure is present, the user hears the warning sound of escaping air.



Simple design: Corrosion



KAESER: No corrosion



Expanded metal mesh



KAESER: Sturdy profiled metal

Corrosion-protected aluminium housing

The enclosures of KAESER FILTER products are cast from seawater-resistant aluminium. Several hundred hours of salt spray testing demonstrate their outstanding corrosion resistance.

Robust stainless steel cage

KAESER filter elements are protected by inner and outer cages made from continuously welded profiled stainless steel. These cages are far more resistant to mechanical stress than those made from simple expanded metal.

KAESER FILTER

To ensure that the required compressed air purity level is consistently maintained, the filter elements should be replaced at the end of their service life. Dependable aerosol filtration also requires dependable condensate drainage. The **ECO-DRAIN 31 F** Vario automatic condensate drain was especially designed for use with coalescence filters. Accumulating condensate is reliably removed with no loss of pressure.



Service life monitoring

The ECO-DRAIN 31 F condensate drain not only monitors its own service interval but also that of the connected compressed air filter element. Service interval status is indicated via LEDs and a floating warning contact.

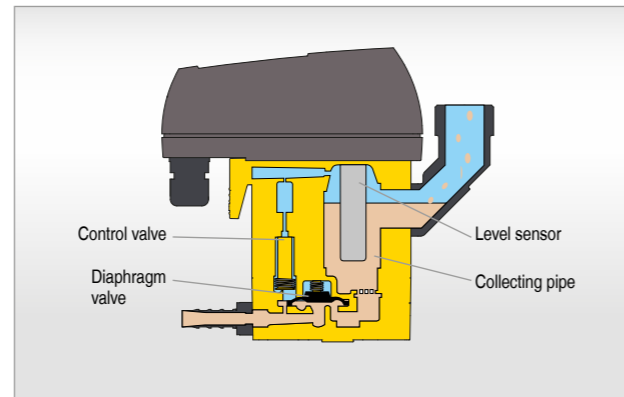

Dependable and loss-free

With contact-free sensing, ECO-DRAIN condensate drains detect the condensate fill level and drain the condensate away via a pilot diaphragm valve without pressure loss. The large flow cross sections eliminate the need for maintenance-intensive strainers.

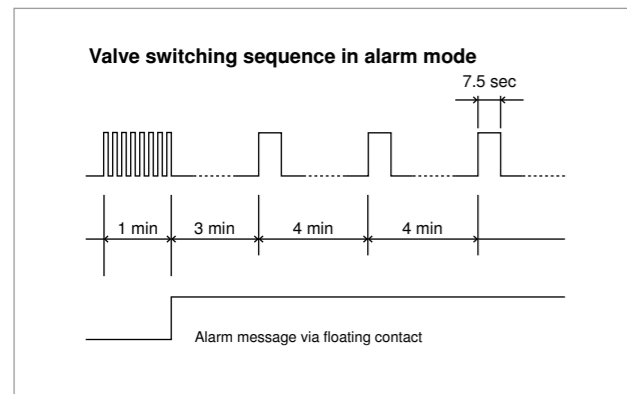

Self-monitoring

Should an issue with condensate drainage occur, the ECO-DRAIN valve opens at short intervals for one minute. If the condensate does not drain, a message is triggered and the valve opens every 4 minutes for 7.5 seconds. Once the condensate drains, the ECO-DRAIN reverts back to normal operation.



Checked for leaks and proper functioning

All wear components of the ECO-DRAIN 31 F can be replaced with the service unit replacement with no need to replace the seal. For trouble-free maintenance, the condensate drain and service unit are 100% factory-tested for leaks and proper functioning before leaving the plant.



Image: Coalescence filter with ECO-DRAIN 31 F

Degree of filtration	ECO-DRAIN 31 F	ECO-DRAIN 30	Automatic condensate drain	Manual condensate drain	Mechanical differential pressure gauge	Differential pressure transducer
KE	To F142	Selectable	Selectable	Selectable	Selectable (For use as microparticle filter downstream from KD filter)	Selectable
	From F184	Selectable	-	-		
KB	To F142	Selectable	Selectable	Selectable	-	Selectable
	From F184	Selectable	-	-		
KD	To F142	-	-	-	Standard	Selectable
	From F184	-	-	-		
KA	To F142	-	-	-	Standard	-
	From F184	-	-	-		

Optimum air quality for your applications



Consistently high efficiency

Fitted as standard to KAESER particle and coalescence filters, the differential pressure gauge enables users to monitor pressure losses (i.e. efficiency) at a glance. Unlike other commonly available systems on the market, the contaminated and clean air sides are isolated from one another.

Equipment



Image 1: KB/KE



Image 2: KB / KE



Image 3: KB / KE



Image 4: KD / KE



Image 5: KA



Image 6: ECO-DRAIN 30



Image 7: ECO-DRAIN 31 F

Coalescence filter with ECO-DRAIN 31 F

Corrosion-protected, coated aluminium housing with connection flanges (configurable nominal widths); locking screw; differential pressure gauge and swivel ball valve (components fully assembled); KB or KE filter element and ECO-DRAIN 31 F electronic condensate drain with maintenance management (included).

Image 1

Coalescence filter with ECO-DRAIN 30

Corrosion-protected, coated aluminium housing with connection flanges (configurable nominal widths); locking screw; differential pressure gauge and swivel ball valve (components fully assembled); KB or KE filter element and ECO-DRAIN 30 electronic condensate drain (included); up to model F142.

Image 2

Coalescence filter with automatic condensate drain

Corrosion-protected, coated aluminium housing with connection flanges (configurable nominal widths); locking screw; differential pressure gauge and automatic condensate drain (components fully assembled); KB or KE filter element (included); up to model F142.

Image 3

Particulate filter

Corrosion-protected, coated aluminium housing with connection flanges (configurable nominal widths); locking screw; differential pressure gauge and manual condensate drain (components fully assembled); KD or KE filter element (included)

Image 4

Activated carbon filter

Corrosion-protected, coated aluminium housing with connection flanges (configurable nominal widths); locking screw, manual condensate drain (components fully assembled); KA filter element (included)

Image 5

ECO-DRAIN 30

Ensures exceptionally safe, reliable condensate drainage without compressed air loss – even under conditions with widely fluctuating condensate accumulation and high particulate / oil content; simple function monitoring at the touch of a button; service unit 100% factory-tested for easy, trouble-free maintenance

Image 6

ECO-DRAIN 31 F

For use with aerosol filters; ensures safe and reliable condensate drainage without compressed air loss; maintenance management system displays elapsed replacement interval for the filter element and service unit (via LED); message for elapsed maintenance intervals provided via floating service contact; additional floating contact for alarm; function test button

Image 7

Other options



Various connection sizes

A range of factory-installed connection flanges is available within each size range of KAESER FILTER products. There is a choice of BSP and NPT threaded connections. KAESER FILTER products can therefore be adapted to the onsite pipe distribution network with no need for reducer sections.



Wall bracket kit

Perfectly fitted and stable wall-mounting brackets are available as an optional accessory for KAESER FILTER units. They attach easily to the connection flanges. The kit permits mounting of filter combinations comprising up to three filters. The installation tool required to enable attachment to the filter head is included.



Differential pressure transducer

Instead of the mechanical differential pressure gauge, KAESER FILTER products can optionally be equipped with a differential pressure transducer (factory-installed). Along with the differential pressure, the three-wire sensor transmits the network pressure downstream from the filter as a 4–20 mA signal. Both values can then be passed on to higher-level control systems such as the SIGMA AIR MANAGER 4.0 and from there can also be transmitted to the SIGMA NETWORK.



Silicone-free version

KAESER FILTER products also include optionally available silicone-free versions that are compliant with test standard PV-VW 3.10.7. Each filter undergoes an individual coating test to confirm compliance. The supplied manufacturer's certificate attests that the product is silicone-free. Moreover, all filter elements for KAESER FILTER products are manufactured to be silicone-free in accordance with this regulation as standard.

Accessories



Flange adapter DN 80 / 3 FLG

For 3-inch connections, flange adapters (DN80/3FLG) at nominal pressure rating PN16 are available as accessories from model F184 upward. In the DIN version, they correspond to the DIN EN 1092-1 standard. In the ASME version they meet the criteria for the ANSI B16.5 - Class 150. The flange adapters have a high-quality anti-corrosion coating and finish.



Connection kit

Multiple KAESER FILTER units can be easily combined onsite with the optional connection kit. It contains the required screws, a gasket and the assembly tool.

Dimensions

Model F6 to F320

Model	A	B	C	D	E	F	G	H
	G	mm	mm	mm	mm	mm	mm	mm
F6	¾	283	308	232	155	87	90	≥ 40
F9	(½, ¾)							
F16	1 (¾)	315	340	259	164	98	100	≥ 40
F22		365	390	308				
F26		365	390	308				
F46	2 (1½, 1¼)	386	411	312	237	153	130	≥ 50
F83		471	496	397				
F110		671	696	597				
F142		671	696	597				
F184	3 (2, 2½)	732	754	643	292	186	150	≥ 50
F250		860	882	771				
F320		1002	1024	913				

G compressed air connections as per ISO 228, optional NPT connections as per ANSI B 1.20.1.

Views

Models shown: F16/F22/F26

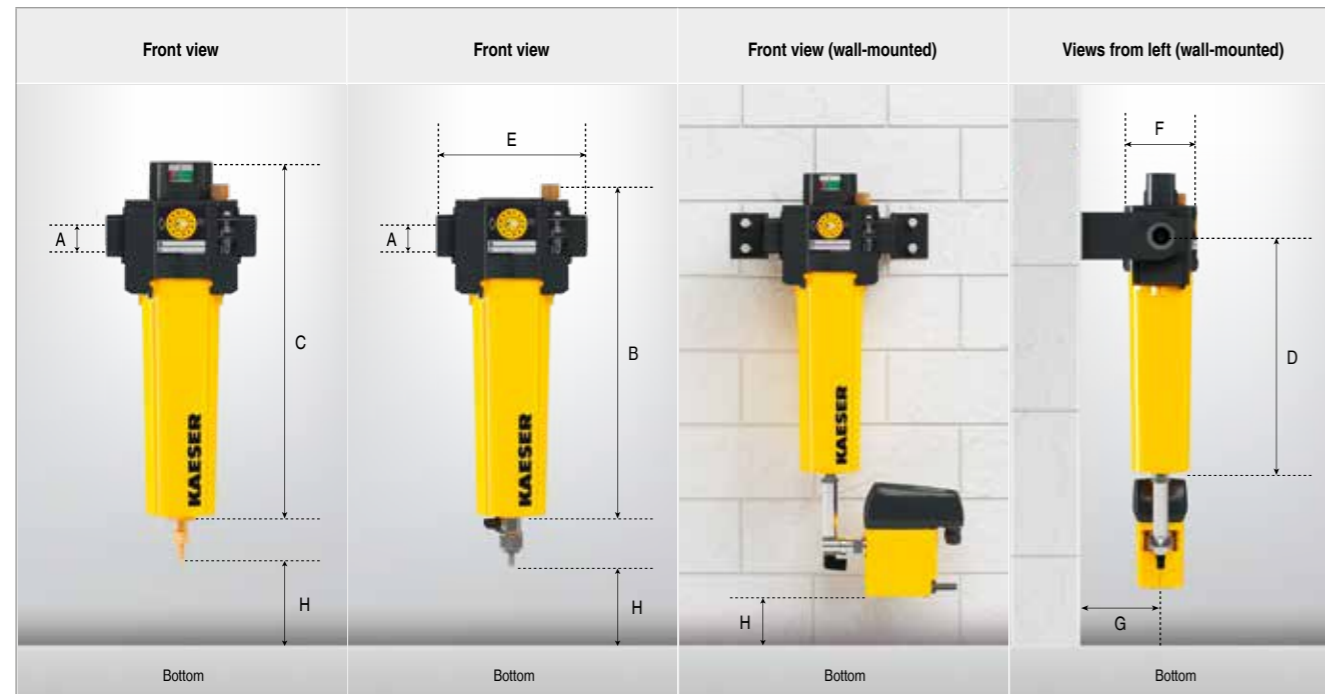

Technical specifications

For models F6 to F320 and filter grades KB/KE/KA/KD

Model	Flow rate ¹⁾	Gauge pressure	Ambient temperature	Inlet temperature Compressed air	Maximum mass	Electrical supply ECO-DRAIN
	m³/min	bar	°C	°C	kg	
F6	0.60	2 to 16	+3 to +50	+3 to +66	3.3	95...240 VAC ±10% (50...60 Hz) / 100...125 VDC ±10%
F9	0.90				3.3	
F16	1.60	2 to 16	+3 to +50	+3 to +66	4.0	
F22	2.20				4.2	
F26	2.60				4.3	
F46	4.61	2 to 16	+3 to +50	+3 to +66	8.2	
F83	8.25				9.1	
F110	11.00				10.7	
F142	14.20				11.1	
F184	18.40	2 to 16	+3 to +50	+3 to +66	16.2	
F250	25.00				17.9	
F320	32.00				19.9	

¹⁾ Performance data at 7 bar gauge pressure based on 1 bar ambient pressure absolute and 20 °C. The flow rate differs for deviating operating conditions.

Calculating flow rate

Correction factors for deviating operating conditions (flow rates in m³/min x k...)

Deviating working pressure p at filter inlet

p bar (g)	2	3	4	5	6	7	8	9	10	11	12	13	14	15	16
k _p	0.38	0.50	0.63	0.75	0.88	1.00	1.06	1.12	1.17	1.22	1.27	1.32	1.37	1.41	1.46

Example:	Selected compressed air filter: F 83 at 8.25 m³/min (V_{Reference})
Pressure: 10 bar(g) (See table)	k _p = 1.17
Max. possible flow rate under operating conditions	
V _{max Operation} = V _{Reference} x k _p	
V _{max Operation} = 8.25 m³/min x 1.17 = 9.65 m³/min	



The world is our home

As one of the world's largest compressed air system providers and compressor manufacturers, KAESER KOMPRESSOREN is represented throughout the world by a comprehensive network of branches, subsidiary companies and authorised partners in over 140 countries.

With innovative products and services, KAESER KOMPRESSOREN's experienced consultants and engineers help customers to enhance their competitive edge by working in close partnership to develop progressive system concepts that continuously push the boundaries of performance and compressed air efficiency.

Moreover, the decades of knowledge and expertise from this industry-leading system provider are made available to each and every customer via the KAESER group's global computer network.

These advantages, coupled with KAESER's worldwide service organisation, ensure that every product operates at the peak of its performance at all times and provides maximum availability.



HPC | Compressed
Air Systems

HPC Compressed Air Systems, Victoria Gardens, Burgess Hill, West Sussex RH15 9RQ
Tel: 01444 241671 Fax: 01444 247304 E-Mail: info@hpcplc.co.uk www.hpccompressors.co.uk