



Boosters

DN C Series

Flow rate 2.9 to 19.6 m³/min – Rated motor power 22 to 45 kW

Initial pressure 3 to 13 bar – Final pressure 10 to 45 bar

Boosters

Boosters are used when pressures higher than the standard system pressure are required at specific points in a production process for technical reasons; PET container production is one of the most well-known examples of such a process. KAESER KOMPRESSOREN is proud to welcome in a new era in booster technology with its innovative complete systems.

Newly designed and requiring less than half of the installation space of previous comparable systems, these compact complete packages – quite literally – have everything you need to ensure a dependable supply of quality high pressure compressed air: The completely new and meticulous design of these packages not only provides optimised cooling air flow, but also enables excellent access for maintenance and service work. Another key advantage is that these new booster packages are perfectly matched for seamless networking with their “suppliers” – making them fully compatible with Industry 4.0 environments.

Energy efficient

IE3 premium efficiency drive motors contribute to cost-effective energy usage as does the generously-dimensioned axial fan which also assures reliable temperature control.

Service-friendly

All maintenance-relevant components, such as cylinders and discharge valves, filters, condensate separators, oil drain and filling openings are quickly and easily accessible thanks to large maintenance doors. The removable panel on the cooler side enables straightforward belt changes and provides easy access to the cooler.

Perfect partners

DN C series boosters are perfect team players for every compressed air station and won't be outdone by their rotary screw “colleagues”: optionally available with air or water cooling, all units come factory-configured for perfect performance in ambient temperatures up to 45 °C.



The same also applies to their networking capabilities: the SIGMA CONTROL 2 system controller ensures full connectivity both within the station, as well as with the SIGMA AIR MANAGER 4.0 master controller – and therefore with Industry 4.0 environments.

All-round reliability

The integrated SIGMA CONTROL 2 controller automatically monitors all key values: initial and final pressure, discharge pressure of the individual cylinders, drive motor winding temperature, oil pressure and level, compressed air discharge temperature, compressor and control cabinet fans and status of maintenance doors (open/closed).

“Plug & Work” complete systems

KAESER's integrated booster systems are completely unique: all application-relevant components are provided and configured ex works to provide a system that's ready for immediate use.

Compact design, impressive performance

KAESER DN C boosters deliver precision-tailored extra pressure, yet have a footprint of only 2.35 m² compared to the previous 5 m² (dotted line). The icing on the cake is that these complete systems are ready for immediate operation: simply install, connect and you're all set!

Image: DN C with one-sided wall installation

Compact and accessible

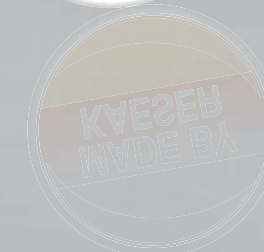



SIGMA CONTROL 2

Designed for boosters

Based on industrial PC technology, the SIGMA CONTROL 2 compressor controller uses specially developed software for use specifically with blowers to ensure maximum dependability and efficiency at all times.

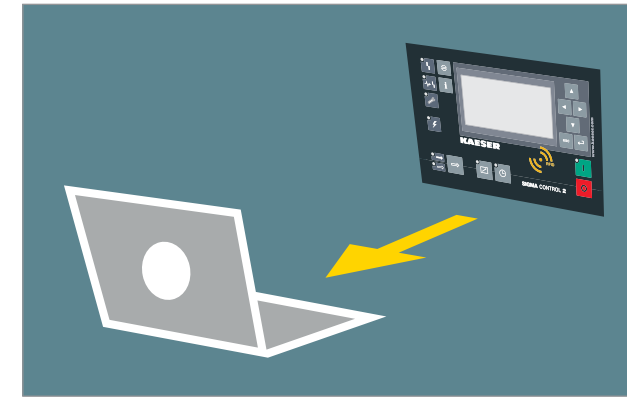

Operating data memory and web server

The SIGMA CONTROL 2 stores up to 1000 messages in its event memory and retains operating data for one year. This greatly simplifies the diagnostics process for precision service and maintenance work. Moreover, the integrated web server enables straightforward display of operating data, maintenance and fault messages on any PC – without the need for specialised software.



Intelligent and dependable control

The SIGMA CONTROL 2 is designed to deliver efficient control and monitoring of compressor operation. Hardware features such as the clear-text display and RFID reader also promote efficient communication and enhanced security. Variable interfaces provide outstanding flexibility, whilst the SD card slot makes updates of the special booster-tailored software a breeze.



Energy-saving IE3 motors

Since all DN series KAESER boosters are powered by IE3 premium efficiency drive motors, they too deliver "More air and more savings" – a characteristic for which KAESER products have become renowned throughout the world.

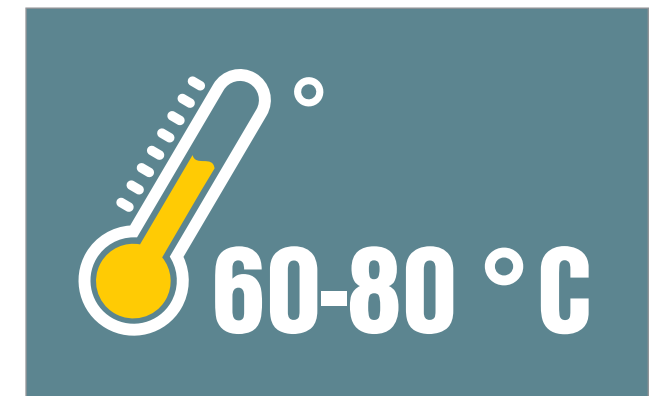

Precision temperature sensor

As part of its comprehensive machine management capabilities, the SIGMA CONTROL 2 also monitors operation-sensitive temperatures. This includes those of the drive motor, where the winding temperature is measured using a high precision platinum temperature sensor.

Simply service-friendly



Aftercooler

The non-depressurised compressed air aftercooler ensures short switching cycles in partial-load operation – yet another valuable energy-saving feature from KAESER's engineers. Furthermore, the generously dimensioned aluminium cooling surfaces reduce the compressed air discharge temperature to near ambient temperature.

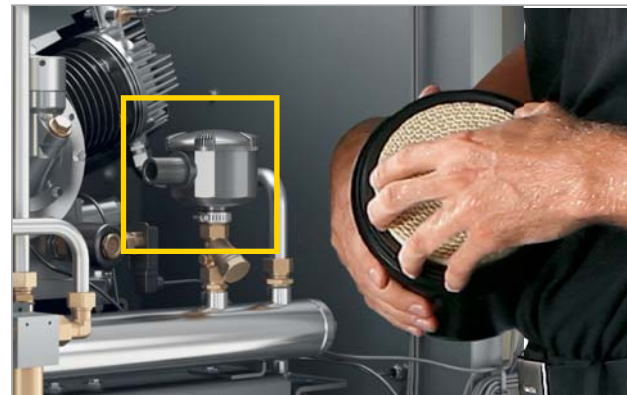

Service-friendly

Just like the air filters which are changed from the front of the unit, all other maintenance parts are easily accessible. Time-saving features such as these streamline and accelerate maintenance and service work, which translates into lower operating costs and increased availability.



Comprehensive sensors

The comprehensive array of sensors and switch contacts for monitoring of pressures, temperatures, oil pressure and oil level ensures reliable booster operation and – thanks to the SIGMA CONTROL 2 – enables remote monitoring and visualisation of operating status, as well as of all recorded data.



E-motors lubricated from the outside

Lubrication of electrical motors must be performed whilst the machine is running – this poses no problem however for DN series boosters since this work can be carried out from outside of the unit and eliminates risk to service personnel. This applies both to the compressor drive motor and the fan motor.

Customisable

Optional equipment

Each DN series booster can be precisely tailored to meet the needs of the specific application.



Nitrogen compression

DN C boosters for nitrogen (N₂) compression are sealed to prevent penetration by outside air and come equipped with additional sensors. Effective pressure reduction during idling periods saves energy whilst ensuring high nitrogen quality.



Adjustable machine mounts

DN series units installed on racks, frames or in containers can be equipped with individually adjustable machine mounts for completely reliable stability at all times.



Water-cooling

Water-cooled DN series boosters are available for applications in which the compressed air discharge temperature must be below the ambient temperature. Water-cooling provides the best heat dissipation and is ideal for use with heat recovery systems.



SIGMA AIR MANAGER 4.0

This powerful master controller provides efficient control and coordinated management of up to 16 pieces of compressed air supply equipment and also monitors associated air treatment components. The SIGMA AIR MANAGER 4.0 also enables full compatibility of all KAESER compressed air supply systems within Industry 4.0 environments.





Sample savings calculation for hot air heat recovery for fuel oil (DN 45C)

Maximum available heat capacity:	49.9 kW	1 kW = 1 MJ/h x 3.6
Fuel value per litre of fuel oil:	9.861 kWh/l	
Fuel oil heating efficiency:	0.9	
Price per litre of fuel oil:	0.70 €/l	

€ 7,872 per year

Cost savings

$\frac{49.9 \text{ kW} \times 2000 \text{ h}}{0.9 \times 9.861 \text{ kWh/l}} \times 0.70 \text{ €/l} =$

Heat recovery

Master class in energy savings

A company's costs for "conventional" space and water heating can be significantly reduced by recovering and utilising recyclable heat from the compressor.

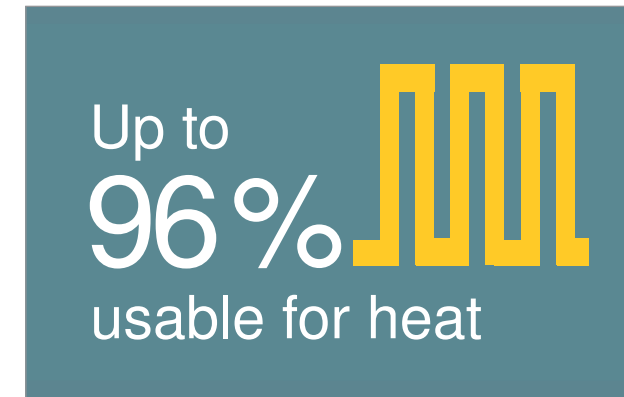

Heat recovery cuts costs

Amazingly, 100 % of the electrical drive energy input to a compressor is converted into heat energy. Of that, up to 96 % is available for heat recovery purposes. If comprehensive heat recovery options are taken into account during the building design phase, production halls can completely dispense with conventional heating systems.



Direct heat recovery

Heating made easy: recoverable heat from air-cooled compressors is collected in manifolds and distributed to the places requiring heating via louvre-controlled air ducts. Naturally this reduces heating costs in winter and the transitions between seasons.



Efficient cooling

More recoverable heat is made available for air heating purposes thanks to the efficient compressed air cooling performance of the aluminium aftercooler. This additionally reduces the load on downstream treatment components and also enhances reliability.



Powerful fan

The exceptionally high residual thrust of the exhaust air fan conveys hot air to the consumption points – even over long duct distances – with no need for auxiliary fans or the associated additional energy costs to run them.

Compressed air stations with boosters

Optimally tailored holistic solutions

Compressed air supply systems that continue to deliver energy efficiency and reliability over the long-term are far more than the sum of their compressors and compressed air treatment components. Moreover, a true systems

provider is capable of making the whole greater than the parts by effectively ensuring harmonious coordination of all components, precisely tailored to individual requirements. KAESER KOMPRESSOREN's compressed air experts

draw on decades of experience when planning and designing your compressed air supply – including low and high pressure applications – to provide a holistic solution that uses only the very highest quality products.

The advantages: true to the KAESER slogan, users benefit from “More compressed air for less energy”.



Image: Compressed air station – low and high pressure

Clever temperature management

Optimised cooling air flow

These boosters feature separate cooling air flows for the compressor block, drive motor and control cabinet, taken in through openings in the right side of the enclosure. At the end of the cooling air flow circuit, these streams are combined and blown out and up through the exhaust air outlet in the top of the enclosure. This clever design fea-

ture reliably prevents cool inlet air from mixing with warm exhaust air – for enhanced efficiency. Thermal load is therefore kept to a minimum: a separate, energy-intensive cooling system for idling is therefore only necessary under extreme conditions.

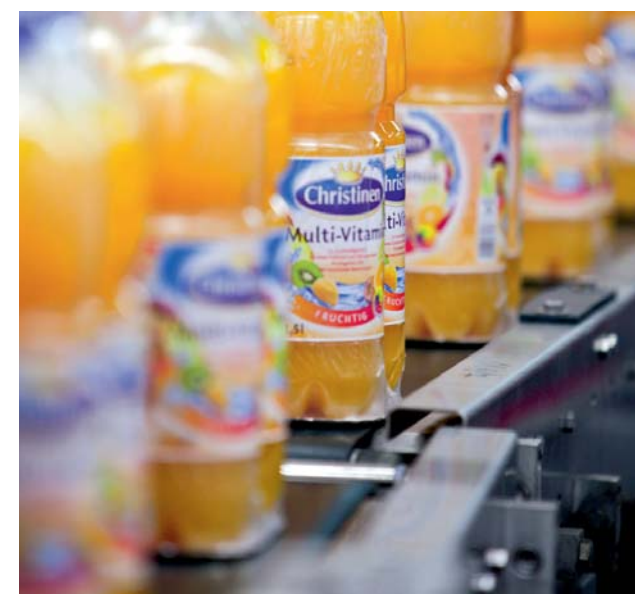
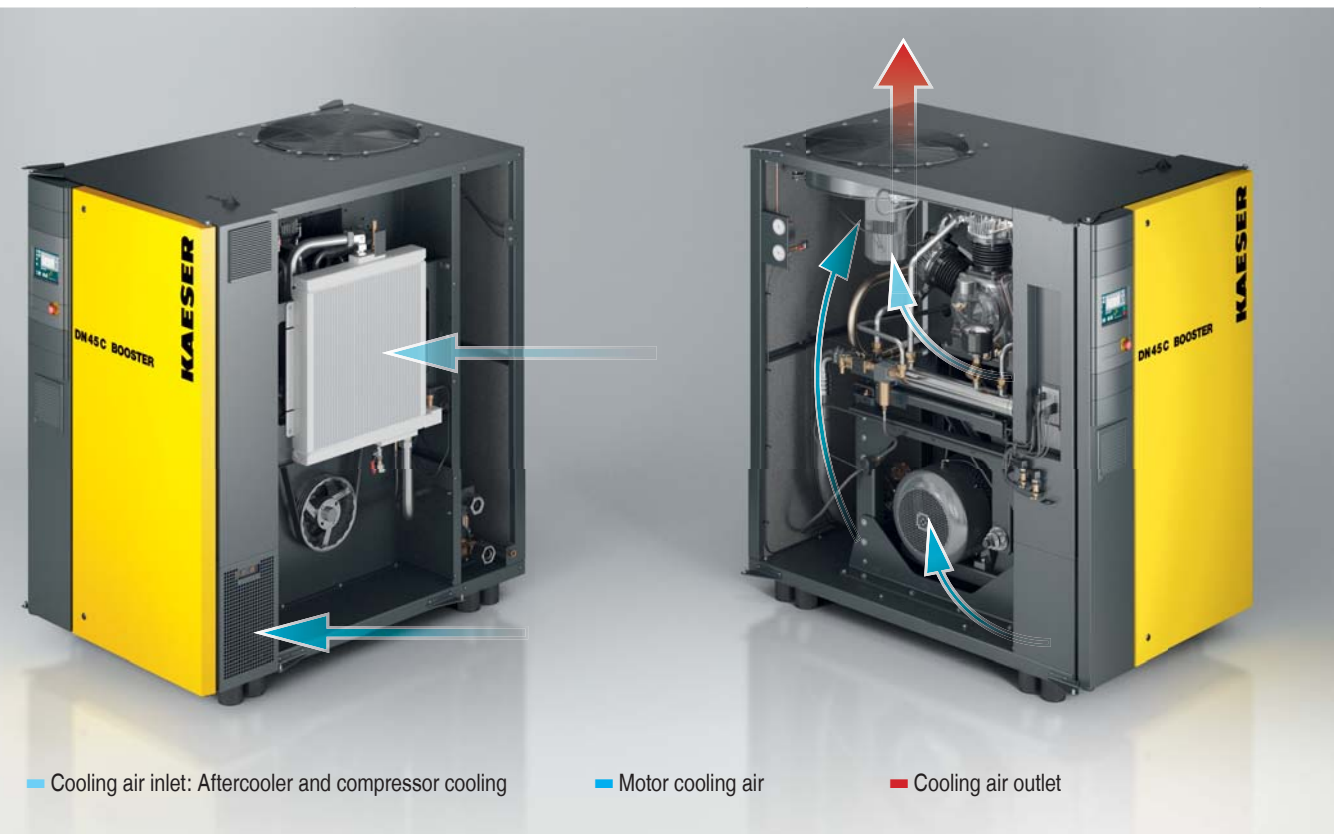

KAESER PET AIR

This all-in-one booster system combines blower and control air in a single, turnkey unit. The rotary screw compressor, blower air booster, controller and compressed air treatment components are all installed on a base frame – and are ready for immediate operation. SIGMA PET AIR is available for flow rates up to 2772 m³/h and with blower air up to 45 bar – all with the outstanding reliability, cost-effectiveness and compressed air quality you've come to expect from KAESER.

Turnkey modules

The new complete solution

DN series boosters are delivered as complete turnkey systems and are precisely tailored to the upstream compressor(s). Thanks to the SIGMA CONTROL 2 controller they are ready for connection and are self-monitoring – a huge advantage in keeping installation time and costs to a minimum. KAESER is therefore the first manufacturer

in the booster sector to offer such user-friendly complete solutions, all neatly contained within one compact enclosure.



Equipment

Complete unit

Ready for operation, fully automatic, soundproofed, vibration-insulated, automatic V-belt tensioning; low motor speeds for long service life and consistently high performance; powder-coated enclosure; suitable for ambient temperatures up to +45 °C; service-friendly design. External lubrication of drive motor and fan motor bearings; high-quality materials, durable build, meticulous assembly and test run.

Oil circuit

The integrated oil pump is driven via the compressor block drive shaft. Pressure lubrication with integrated oil filter allows seamless oil distribution. Reliable operation is ensured by continuous oil pressure and oil level monitoring.

Water-cooled version (option)

Equipped with a shell and tube heat exchanger made from CuNi10Fe.

Nitrogen version (option)

In partial-load operation the special bypass control reliably prevents ambient air from entering the system. Care must be taken to ensure that only dry nitrogen (max. 20 % relative humidity) is drawn in.

In the DNC series, controlled actuation of the valves further reduces idle pressure and idling power consumption. Additional sensors provide enhanced operational reliability.

Electrical components

Premium efficiency IE3 drive motor with PT-100 windings temperature sensor for motor monitoring, separate axial fan with high residual thrust, control cabinet to IP 54 protection rating, control cabinet ventilation, automatic star-delta combination, overload relay, control transformer, initial and discharge pressure sensors, PT-100 sensor for discharge temperature from the individual cylinders and compressed air discharge temperature, oil pressure sensor and oil fill-level switch, limit switch on the cooler-side patch panel.

SIGMA CONTROL 2

'Traffic light' style LEDs show operational status at a glance; clear text display, 30 selectable languages, soft-touch pictogram keys; fully-automatic monitoring and control; interfaces: Ethernet; additional optional communication modules for: Profibus DP, Modbus, Profinet and Devicenet. SD memory card slot (8 GB card as standard) for data storage and updates; RFID reader, web server – graphic display of measurement and operating data as well as status display (load run, idling and stop) and message history (operating, warning and fault messages).

SIGMA AIR MANAGER 4.0

The further-refined adaptive 3-D^{advanced} Control predictively calculates and compares various operating scenarios and selects the most efficient to suit the compressed air application's specific needs.

The SIGMA AIR MANAGER 4.0 therefore automatically optimally adjusts flow rates and compressor energy consumption in response to current compressed air demand. This powerful feature is made possible by the integrated industrial PC with multi-core processor in combination with adaptive 3-D^{advanced} Control. Furthermore, the SIGMA NETWORK bus converters (SBC) provide a host of possibilities to enable the system to be individually tailored to meet exact user requirements. The SBC can be equipped with digital and analogue input and output modules, as well as with SIGMA NETWORK ports, to enable seamless display of flow rate, pressure dew point, power or alarm message information.

Amongst other key features, the SIGMA AIR MANAGER 4.0 provides long-term data storage capability for reporting, controlling and audits, as well as for energy management tasks as per ISO 50001.

(See image on right)

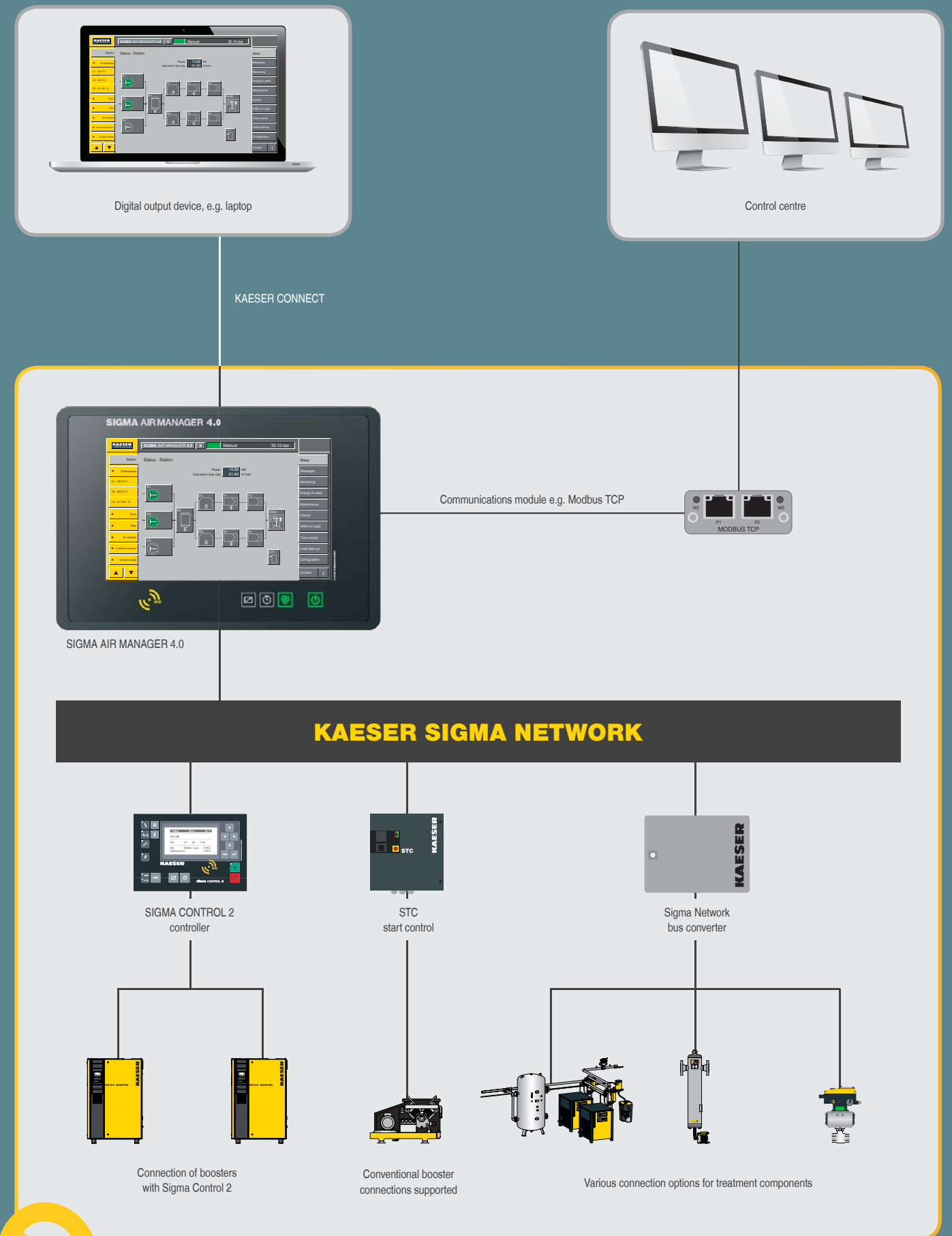

Secure data – secure business!

Technical specifications

Air-cooled version (50 Hz)

Model	Initial pressure	Final pressure	Flow rate	Compressor block speed	No. of cylinders	Sound pressure level	Compressed air connection		Dimensions W x D x H	Mass
	bar	bar	m³/min	Strokes per min			Inlet side	Discharge side		
DN 22 C	5	25	4.7	1315	3	78	G 2	G 1½	1280 x 1830 x 1960	1270
	7.5	30	6.2	1139						
	10	35	7.0	981						
	13	40	7.8	833						
DN 30 C	5	25	6.1	1139	3	78	G 2	G 1½	1280 x 1830 x 1960	1370
	7.5	30	8.2	1034						
	10	35	9.6	1315						
	13	40	10.8	1139						
DN 37 C	7.5	30	9.4	1183	3	78	G 2	G 1½	1280 x 1830 x 1960	1400
	10	35	10.8	1034						
	13	40	12.6	1315						
DN 45 C	7.5	25	10.7	1315	3	78	G 2	G 1½	1280 x 1830 x 1960	1410
	7.5	30	9.7	1227						
	10	35	12.9	1227						
	13	40	14.9	1095						

Water-cooled version (50 Hz)

Model	Initial pressure	Final pressure	Flow rate	Compressor block speed	No. of cylinders	Sound pressure level	Compressed air connection		Dimensions W x D x H	Mass
	bar	bar	m³/min	Strokes per min			Inlet side	Discharge side		
DN 22 C	5	25	4.7	1315	3	75	G 2	G 1½	1280 x 1830 x 1960	1240
	7.5	30	6.2	1139						
	10	35	7.0	981						
	13	40	7.8	833						
DN 30 C	5	25	6.1	1139	3	75	G 2	G 1½	1280 x 1830 x 1960	1340
	7.5	30	8.2	1034						
	10	35	9.6	1315						
	13	40	10.8	1139						
DN 37 C	7.5	30	9.4	1183	3	75	G 2	G 1½	1280 x 1830 x 1960	1370
	10	35	10.8	1034						
	13	40	12.6	1315						
DN 45 C	7.5	25	10.7	1315	3	75	G 2	G 1½	1280 x 1830 x 1960	1370
	7.5	30	9.7	1227						
	10	35	12.9	1227						
	13	40	14.9	1095						

*) Flow rate complete system as per ISO 1217: 2009, Annex C: Absolute intake pressure 1 bar (a), cooling and air intake temperature 20 °C

**) Sound pressure level as per ISO 2151 and the basic standard ISO 9614-2, tolerance: ± 3 dB (A)

How it works

Air-cooled version

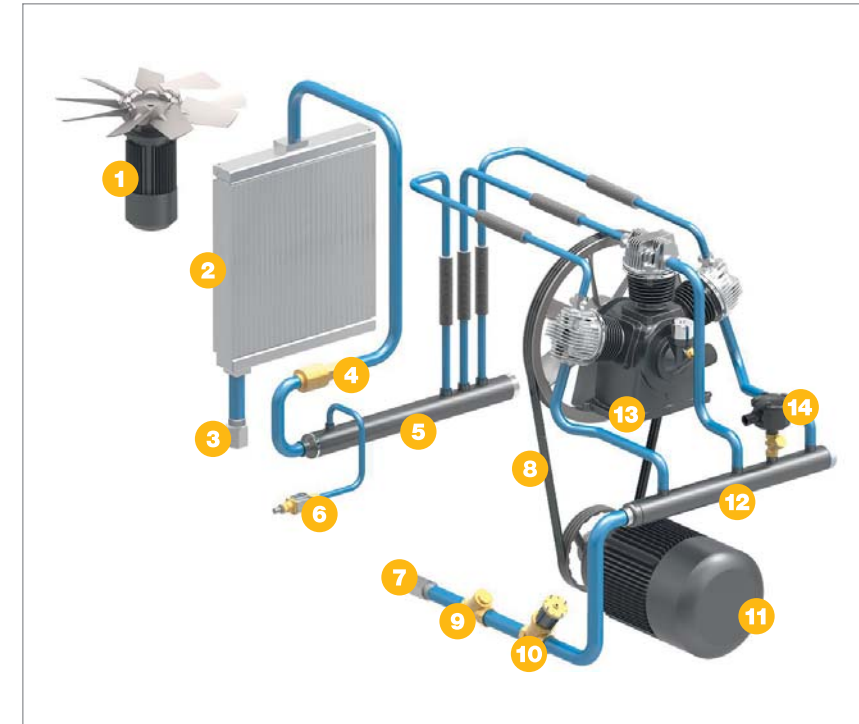

- 1) Fan motor
- 2) Air cooler (air-cooled)
- 3) Compressed air outlet
- 4) Pressure-side check valve
- 5) Pressure-side manifold
- 6) Relief valve
- 7) Compressed air inlet
- 8) V-belt
- 9) Inlet side dirt trap
- 10) Inlet valve
- 11) Compressor motor
- 12) Inlet side manifold
- 13) Compressor block
- 14) Air filter for idling control

Water-cooled version

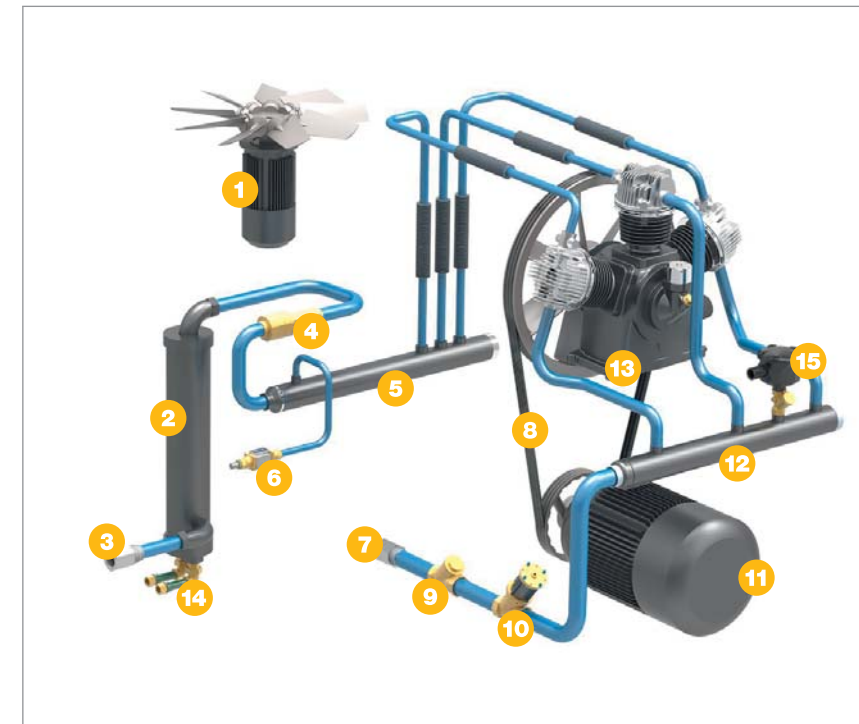

- 1) Fan motor
- 2) Water cooler (water-cooled)
- 3) Compressed air outlet
- 4) Pressure-side check valve
- 5) Pressure-side manifold
- 6) Relief valve
- 7) Compressed air inlet
- 8) V-belt
- 9) Inlet side dirt trap
- 10) Inlet valve
- 11) Compressor motor
- 12) Inlet side manifold
- 13) Compressor block
- 14) Cooling air connections
- 15) Air filter for idling control

The world is our home

As one of the world's largest compressed air systems providers and compressor manufacturers, KAESER KOMPRESSOREN is represented throughout the world by a comprehensive network of branches, subsidiary companies and authorised partners.

With innovative products and services, KAESER KOMPRESSOREN's experienced consultants and engineers help customers to enhance their competitive edge by working in close partnership to develop progressive system concepts that continuously push the boundaries of performance and compressed air efficiency. Moreover, the decades of knowledge and expertise from this industry-leading system provider are made available to each and every customer via the KAESER group's global computer network.

These advantages, coupled with KAESER's worldwide service organisation, ensure that every product operates at the peak of its performance at all times and provides maximum availability.



HPC | Compressed
Air Systems

HPC Compressed Air Systems, Victoria Gardens, Burgess Hill, West Sussex RH15 9RQ
Tel: 01444 241671 Fax: 01444 247304 E-Mail: info@hpcplc.co.uk www.hpccompressors.co.uk